

KOMATSU

PC
170LC

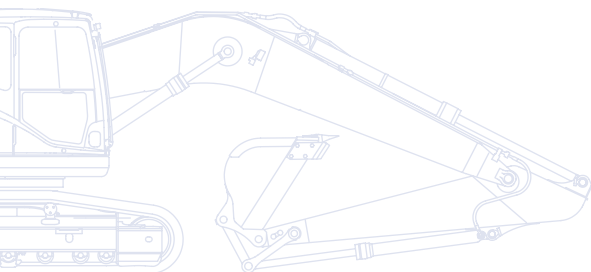

Hydraulic Excavator **PC170LC-10**



ENGINE POWER
90 kW / 121 HP @ 2.100 rpm

OPERATING WEIGHT
17.280 - 17.940 kg

BUCKET CAPACITY
max. 0,94 m³

Walk-Around

Built around the EU Stage IIIB engine platform, Komatsu's latest generation of excavators continues a long tradition of uncompromising quality and total customer support, while renewing a commitment to safety and environmental protection. Increased net horsepower, lower fuel consumption and emissions, and the advanced electronic control system that manages air flow rate, fuel injection and combustion parameters to optimize performance and further reduce particulate matter and nitrogen oxides in the exhaust: you can trust "Dash 10" machines to keep their promises of excellence.

Powerful and environmentally friendly

- Low consumption EU Stage IIIB
- Fuel-saving engine and hydraulic technology
- Adjustable Eco-gauge and idle caution
- Reduced wastage

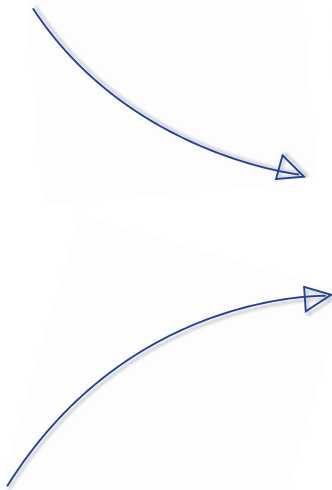

KOMTRAX

Komatsu Wireless
Monitoring System

Total versatility

- Ideal for a wide range of applications
- 6 working modes
- Wide choice of options
- Built-in versatility
- High lift capacity



A maintenance program
for Komatsu customers

PC170LC-10

ENGINE POWER
90 kW / 121 HP @ 2.100 rpm

OPERATING WEIGHT
17.280 - 17.940 kg

BUCKET CAPACITY
max. 0,94 m³

First-class operator comfort

- Fully air suspended operator station
- Low noise design
- Low vibration levels
- Large, widescreen hi-res display monitor
- Improved operator convenience



Highest safety standards

- Safe SpaceCab™
ROPS compliant with ISO 12117-2:2008
- Low profile rear view camera
- Optimal jobsite safety
- Safe access, easy maintenance
- Falling Object Protection System (FOPS) optional



Quality you can rely on

- Reliable and efficient
- Rugged design
- Komatsu-quality components
- Extensive dealer support network

Total Versatility

Ideal for a wide range of applications

Powerful and precise, the Komatsu PC170LC-10 is equipped to efficiently carry out any task your business requires. On big sites or small, for digging, trenching, landscaping or site preparation, the Komatsu original equipment hydraulic system always ensures maximum productivity and control.

6 working modes

Power, Lifting, Breaker, Economy, Attachment Power and Attachment Economy modes are all available, ensuring that the PC170LC-10 delivers the power you need with minimised fuel usage. The Economy mode can be adjusted for an ideal balance between power and economy to match your work. The oil flow delivered to hydraulic attachments is adjustable directly on the class-leading wide screen monitor panel.

High lift capacity

Along with its class leading compact size, the PC170LC-10 features an unrivalled lifting performance. The combination of power, convenient dimensions and complete control makes the PC170LC-10 the first choice for heavy duty lifting applications or simple excavating tasks in narrow alleys, road-construction sites and for sewer-construction work.

Built-in versatility

A standard fit additional hydraulic circuit, controlled by a sliding joystick push button and a floor mounted pedal, gives the PC170LC-10 excellent versatility. Ten attachment memory settings are provided, with individually definable names. In combination with the standard-fit hydraulic quick coupler power circuit, changing working style is now even simpler. A second auxiliary hydraulic line is available for attachments which require extra hydraulic actuation.

A wide choice of options

With a choice of arms and undercarriages, you can configure the PC170LC-10 to match specific demands for transport, working envelope or duty. Extra hydraulic arrangements are available for every boom and arm configuration, making sure that the machine always contributes strongly to your business.





Powerful and Environmentally Friendly

New Komatsu engine technology

The powerful and fuel-efficient Komatsu SAA4D107E-2A engine in the PC170LC-10 delivers 90 kW / 121 HP and is EU Stage IIIB certified. To maximise power, fuel efficiency and emission compliance, it is turbo charged and features direct fuel injection, air-to-air after cooling and cooled EGR.

Fuel-saving engine and hydraulic technology

The PC170LC-10 features variable speed matching of the engine and hydraulic pump, and an automatic low idle. The new engine and pump control technology lower total fuel consumption and guarantee efficiency and precision during single and combined movements.

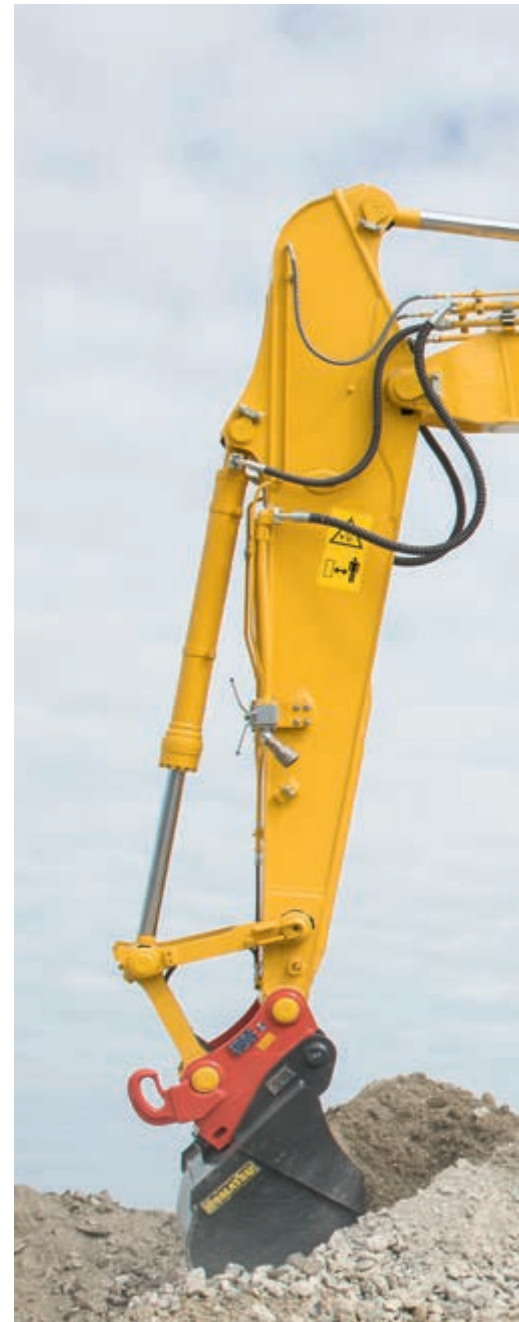

Komatsu Diesel Oxidation Catalyst (KDOC)

A simple and high efficiency diesel oxidation catalyst that eliminates the need for PM regeneration and simplifies the engine control system. It integrates a high performance exhaust noise silencer and helps to reduce engine noise.

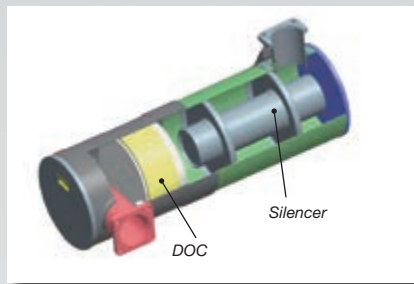

Exhaust Gas Recirculation (EGR)

Cooled EGR is a technology well-proven in current Komatsu engines. The increased capacity of the EGR cooler now ensures very low NOx emissions and a better engine performance.

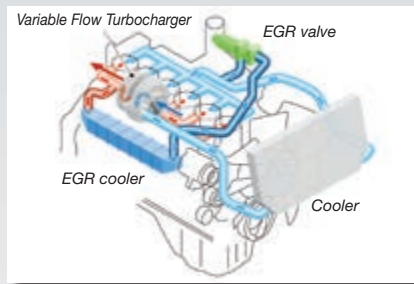

Variable Flow Turbocharger (VFT)

Varies the intake air flow. The wheel speed of the exhaust turbine is controlled by a valve for optimum air flow to the engine combustion chamber, under any load or speed conditions. The exhaust gas is cleaner, with no reduction in power or performance.

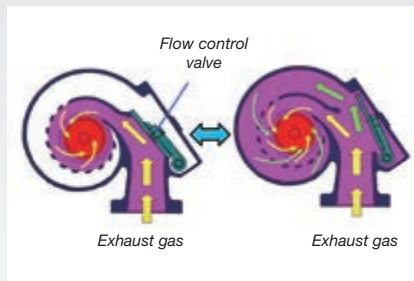

Komatsu Closed Crankcase Ventilation (KCCV)

Crankcase emissions (blow-by gas) are passed through a CCV filter. The oil mist trapped in the filter is returned back to the crankcase while the filtered gas is returned to the air intake.

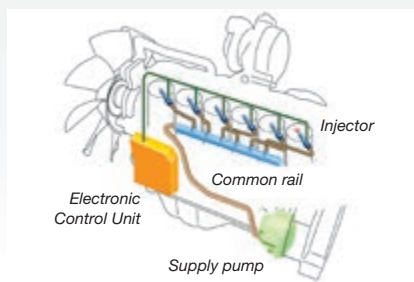

High-Pressure Common Rail (HPCR)

To achieve complete fuel burn and lower exhaust emissions, the heavy duty High-Pressure Common Rail fuel injection system is computer controlled to deliver a precise quantity of pressurised fuel into the redesigned engine combustion chamber by multiple injections.

Reduced wastage

Standard equipment on all PC170LC-10 includes an electric fuel pump, simple to operate and with an automatic shut-off. To further increase the system's safety, a barrier and special foams help to avoid any spilt fuel flowing towards hot areas of the machine.



More fuel-saving technology

The selectable engine mode and adjustable idle shutdown are tools to considerably lower fuel usage. The PC170LC-10's Eco-gauge displays active recommendations on the cab's monitor to help you maximise those fuel savings.



Active ECO recommendations



ECO guidance menu

First-Class Operator Comfort

Newly designed, spacious cab

The wide spacious cab features a new, fully air suspended operator control station that incorporates the side consoles mounted together with a high back, fully adjustable seat, heated for improved comfort.

Improved operator convenience

With increased in-cab storage space, an auxiliary input (MP3 jack) and 12 V and 24 V power supply, the cab offers maximum convenience. The automatic air conditioner allows the operator to easily and precisely set the cab's atmosphere.

Low noise design

Komatsu Dash 10 crawler excavators have very low external noise levels and are especially well-suited for work in confined spaces or urban areas. Reduced fan speed, a large capacity radiator, and the optimal usage of sound insulation and of sound absorbing materials help to make noise levels inside Dash 10 excavators comparable to those inside an executive car.

Cab damper mounting

The built-in stability of the Komatsu PC170LC-10, combined with a highly rigid deck and a sprung multi-layer viscous mount system, drastically reduces vibration levels for the operator.



Automatic air conditioner



Hot and cool box



Joysticks with proportional control button for attachments





Large, widescreen hi-res display monitor

To enable safe, accurate and smooth work, the user friendly monitor is the highly intuitive user interface for the machine's Equipment Management and Monitoring System (EMMS). Easily customized and with a choice of 25 languages, it features simple switches and multifunction keys that provide the operator with fingertip access to a wide range of functions and operating information.



Highest Safety Standards

Safe SpaceCab™

The new cab is ROPS compliant with ISO 12117-2:2008. It has a tubular steel frame and provides very high shock absorbency, impact resistance and durability. The seat belt is designed to keep the operator in the safety zone of the cab in the event of a roll-over. Optionally it can be fitted with an ISO 10262 Level 2 Falling Object Protective System (FOPS) with openable front guard.

Safe and easy maintenance

Thermal guards are placed around high temperature parts of the engine. The fan belt and pulleys are well protected and in case of damage, fire risk is reduced by a pump/engine partition that prevents hydraulic oil from spraying onto the engine. The engine hood is hinged to the rear, with anti-slip plates positioned around the engine bay to ensure safe and easy access from all sides. Exceptionally sturdy handrails further contribute to a high safety level.

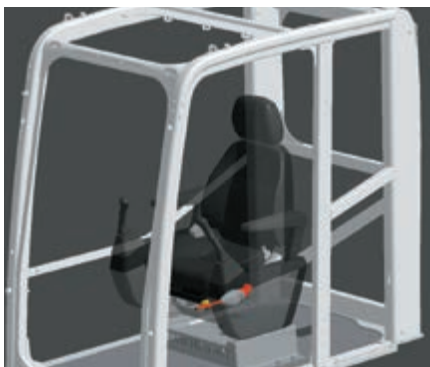

Safe SpaceCab™

Optimal job site safety

Safety features on the Komatsu PC170LC-10 comply with the latest industry standards and work together as a system to minimise risks to personnel in and around the machine. An audible travel alarm further promotes job site safety. Highly durable anti-slip plates – with additional high friction covering – maintain long term traction performance.

Rear view camera

A standard fitment camera gives an exceptionally clear view of the rear work zone on the wide-screen monitor panel. The low profile camera is adjustable and integrated into the counterweight's shape. On request, another camera can be added to the right side of the machine.



Low profile rear view camera



Large handrails

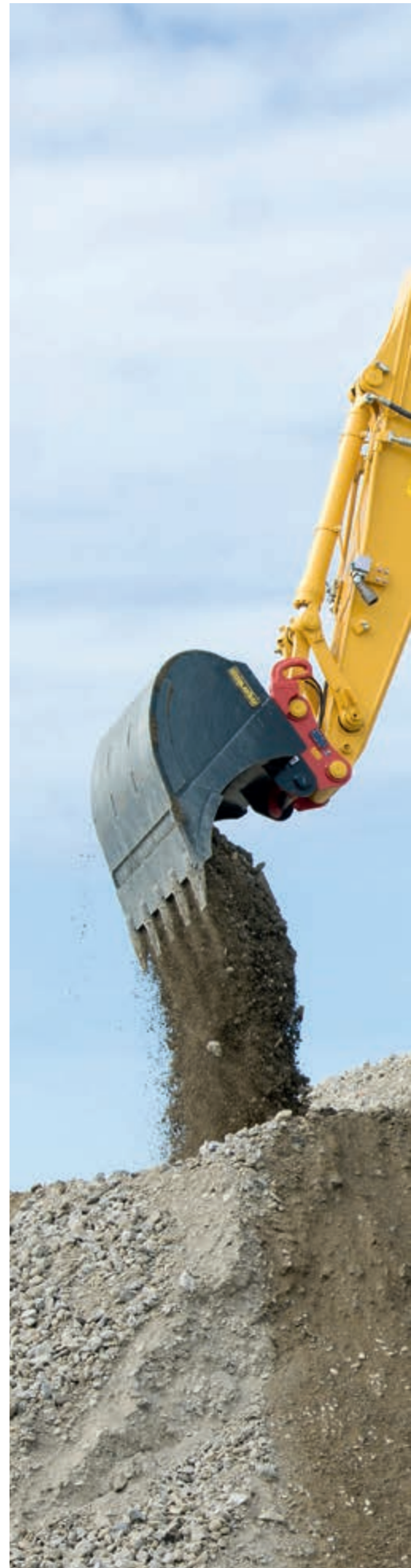



Quality You Can Rely On

Reliable and efficient

Productivity is the key to success – all major components of the PC170LC-10 are designed and directly manufactured by Komatsu. Essential machine functions are perfectly matched for a highly reliable and productive machine.

Rugged design

Maximum toughness and durability – along with top class customer service – are the cornerstones of Komatsu's philosophy. Single piece plates and castings are used in key areas of the machine's structure for good load distribution. Highly durable rubbing strips on the underside of the arm protect the structure against material falling from the bucket.

Komatsu-quality components

With the latest computer design techniques and a thorough test programme, Komatsu's global know-how produces machines that are designed, manufactured and tested to meet your highest standards.

Extensive dealer support network

The extensive Komatsu distribution and dealer network is standing by to help keep your fleet in optimum condition. Customised servicing packages are available, with express availability of spare parts, to make sure that your Komatsu will continue to perform at its peak.



Single piece boom plates





Komatsu Wireless Monitoring System

The easy way to higher productivity

KOMTRAX™ is the latest in wireless monitoring technology. It delivers insightful and cost saving information about your fleet and equipment and offers you a wealth of information to facilitate peak machine performance. By creating a tightly integrated web of support it allows pro active and preventive maintenance and helps you to efficiently run a business.

Knowledge

You get quick answers to basic and critical questions about your machines – what they're doing, when they did it, where they're located, how they can be used more efficiently, and when they need to be serviced. Performance data is relayed by satellite from your machine to your computer and to your local Komatsu distributor – who's readily available for expert analysis and feedback.

Convenience

KOMTRAX™ helps to conveniently manage your fleet on the web, wherever you are. Data is analysed and packaged specifically for easy and intuitive viewing in maps, lists, graphs and charts. You can anticipate the type of service and parts your machines could require, or troubleshoot problems before Komatsu technicians arrive on site.





Power

The detailed information that KOMTRAX™ puts at your fingertips 24 hours a day, 7 days a week gives you the power to make better daily and long-term strategic decisions. You can anticipate problems, customize maintenance schedules, minimize downtime and keep your machines where they belong – working on the job site.



Through the web application, a variety of search parameters are available to quickly find information about specific machines based on key factors such as utilization rates, age, various notification messages, and more.

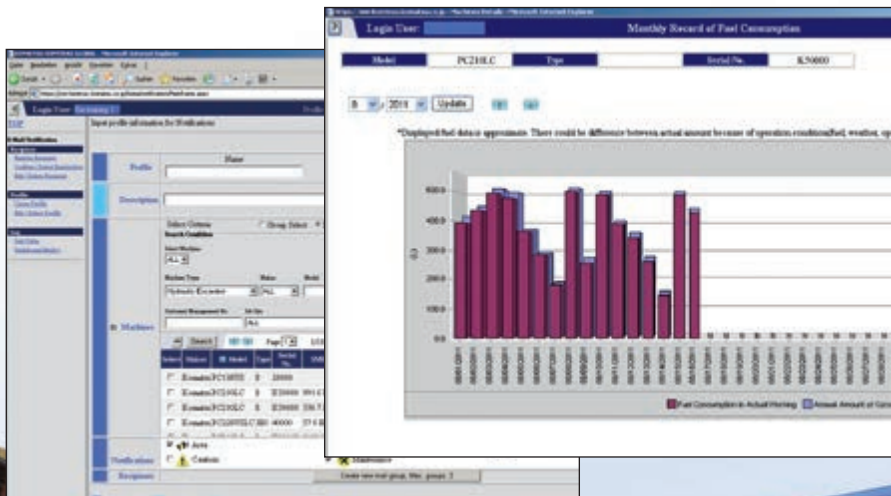

A simple chart shows the machine's fuel consumption and helps you to calculate total costs for a job site and conveniently schedule fuel deliveries.

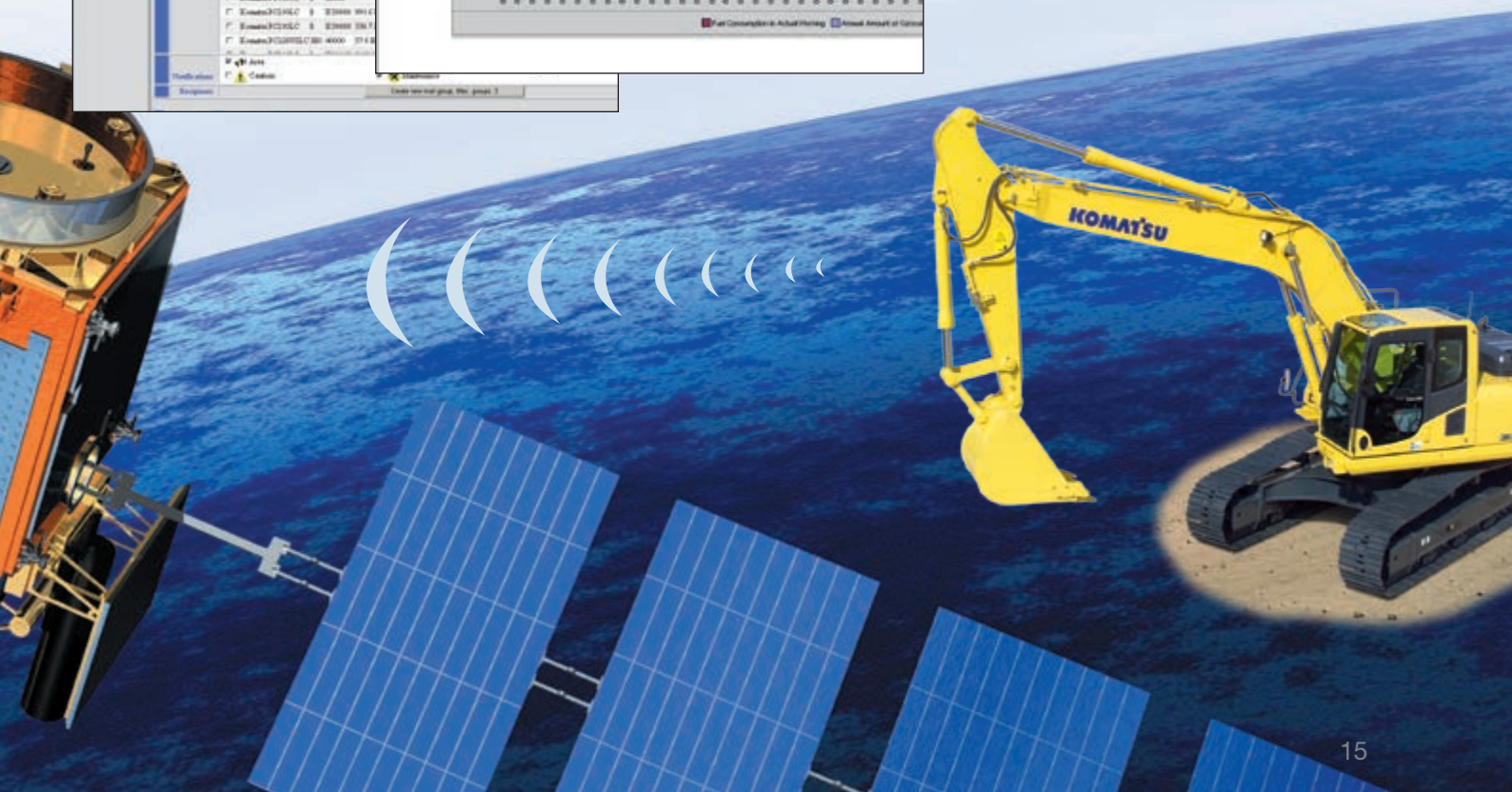

Easy Maintenance

Easy cleaning of coolers

Hinged air conditioning cooler and side-by-side radiator and oil cooler allow easy access for cleaning.



Quick access to filters and fuel drain valve

The engine oil filter, the fuel filters and the fuel drain valve are mounted remotely to make them accessible from ground level.

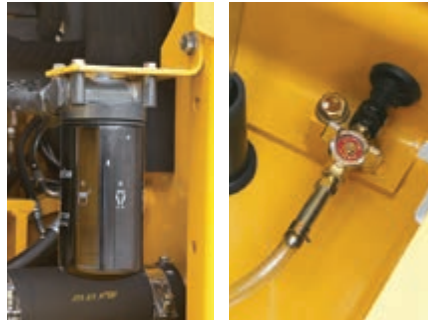

Gas-assisted engine hood damper cylinders

The engine hood can be easily opened and closed with help of the gas-assisted engine hood damper cylinders.



Komatsu CARE™ is a maintenance program that comes as standard with your new Komatsu machine. It covers factory-scheduled maintenance, performed with Komatsu Genuine parts by Komatsu-trained technicians. Depending on your machine's engine, it also offers extended coverage of the Komatsu Diesel Particulate Filter (KDPF) or the Komatsu Diesel Oxidation Catalyst (KDOC), and of the Selective Catalytic Reduction (SCR). Please contact your local Komatsu distributor for terms and conditions.

Water separator

This is standard equipment which removes any water that has become mixed with the fuel, preventing fuel system damage.



Long-life oil filters

The hydraulic oil filter uses high-performance filtering material for long element replacement intervals, which significantly reduces maintenance costs.



ENGINE

Model	Komatsu SAA4D107E-2A
Type	Common rail direct injection, water-cooled, emissionised, turbocharged, after-cooled diesel
Engine power	
at rated engine speed	2.100 rpm
ISO 14396	90 kW / 121 HP
ISO 9249 (net engine power)	85,7 kW / 115 HP
No. of cylinders	4
Bore x stroke	107 x 124 mm
Displacement	4,46 ltr
Battery	2 x 12 V/120 Ah
Alternator	24 V/60 A
Starter motor	24 V/4,5 kW
Air filter type	Double element type with monitor panel dust indicator and auto dust evacuator
Cooling	Suction type cooling fan with radiator fly screen

HYDRAULIC SYSTEM

Type	HydrauMind. Closed-centre system with load sensing and pressure compensation valves
Main pump	Variable-capacity piston pump
Pumps for	Boom, arm, bucket, swing, and travel circuits
Maximum pump flow	298 ltr/min
Relief valve settings	
Implement	380 kg/cm ²
Travel	380 kg/cm ²
Swing	295 kg/cm ²
Pilot circuit	33 kg/cm ²

UNDERCARRIAGE

Construction	X-frame centre section with box section track frames
Track assembly	
Type	Fully sealed
Shoes (each side)	44
Tension	Combined spring and hydraulic unit
Rollers	
Track rollers (each side)	7
Carrier rollers (each side)	2

OPERATING WEIGHT (APPR.)

Triple grouser shoes	Mono boom	
	Operating weight	Ground pressure
500 mm	17.280 kg	0,50 kg/cm ²
600 mm	17.500 kg	0,42 kg/cm ²
700 mm	17.720 kg	0,37 kg/cm ²
800 mm	17.940 kg	0,33 kg/cm ²

Operating weight, including specified work equipment, 2,6 m arm, 0,65 m³ bucket, operator, lubricant, coolant, full fuel tank and the standard equipment.

SWING SYSTEM

Type	Axial piston motor driving through planetary double reduction gearbox
Swing lock	Electrically actuated wet multi-disc brake integrated into swing motor
Swing speed	0 - 12 rpm
Swing torque	45 kNm
Max. pressure	295 kg/cm ²

DRIVES AND BRAKES

Steering control	2 levers with pedals giving full independent control of each track
Drive method	Hydrostatic
Gradeability	70%, 35°
Max. travel speeds	
Lo / Hi	3,0 / 5,5 km/h
Maximum drawbar pull	15.950 kg

SERVICE REFILL CAPACITIES

Fuel tank	300 ltr
Radiator	23,5 ltr
Engine oil	18,0 ltr
Swing drive	4,5 ltr
Hydraulic tank	121 ltr
Final drive (each side)	5,4 ltr

ENVIRONMENT

Engine emissions	Fully complies with EU Stage IIIB exhaust emission regulations
Noise levels	
LwA external	101 dB(A) (2000/14/EC Stage II)
LpA operator ear	68 dB(A) (ISO 6396 dynamic test)
Vibration levels (EN 12096:1997)	
Hand/arm	≤ 2,5 m/s ² (uncertainty K = 0,48 m/s ²)
Body	≤ 0,5 m/s ² (uncertainty K = 0,23 m/s ²)
Contains fluorinated greenhouse gas HFC-134a (GWP 1430).	
Quantity of gas 0,9 kg, CO ₂ equivalent 1,29 t	

Dimensions & Performance Figures

MACHINE DIMENSIONS

A	Overall width of upper structure	2.490 mm
B	Overall height of cab	3.035 mm
C	Overall length of basic machine	4.450 mm
D	Tail length	2.470 mm
	Tail swing radius	2.500 mm
E	Clearance under counterweight	1.055 mm
F	Machine tail height	2.515 mm
G	Ground clearance	440 mm
H	Tumbler centre distance	3.170 mm
I	Track length	3.965 mm
J	Track gauge	1.990 mm
K	Track shoe width	500, 600, 700, 800 mm
L	Overall track width with 500 mm shoes	2.490 mm
	Overall track width with 600 mm shoes	2.590 mm
	Overall track width with 700 mm shoes	2.690 mm
	Overall track width with 800 mm shoes	2.790 mm

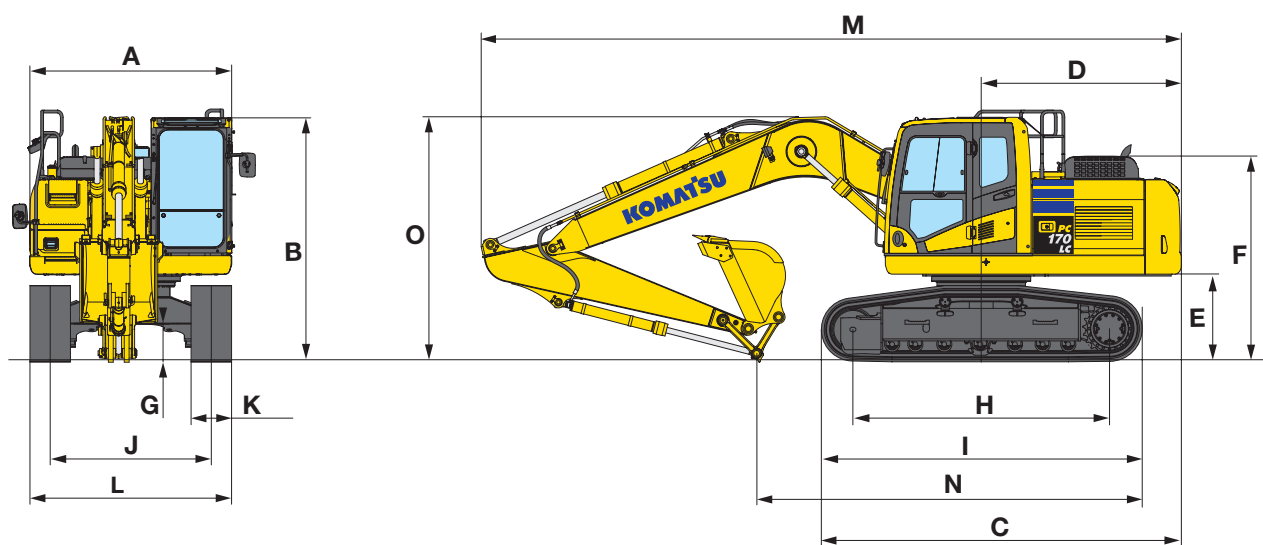

TRANSPORT DIMENSIONS

	Arm length	Mono boom		
		2,25 m	2,6 m	2,9 m
M	Transport length	8.645 mm	8.645 mm	8.645 mm
N	Length on ground (transport)	5.130 mm	4.760 mm	4.565 mm
O	Overall height (to top of boom)	3.030 mm	3.040 mm	3.140 mm



MAX. BUCKET CAPACITY AND WEIGHT

Arm length	Mono boom					
	2,25 m		2,6 m		2,9 m	
Material weight up to 1,2 t/m ³	0,94 m ³	615 kg	0,94 m ³	615 kg	0,75 m ³	530 kg
Material weight up to 1,5 t/m ³	0,75 m ³	530 kg	0,75 m ³	530 kg	0,75 m ³	530 kg
Material weight up to 1,8 t/m ³	0,66 m ³	495 kg	0,66 m ³	495 kg	0,66 m ³	495 kg

Max. capacity and weight have been calculated according to ISO 10567:2007.

Please consult with your distributor for the correct selection of buckets and attachments to suit the application.

BUCKET AND ARM FORCE

Arm length	2,25 m	2,6 m	2,9 m
Bucket digging force	11.100 kg	11.100 kg	11.100 kg
Bucket digging force at PowerMax	12.500 kg	12.500 kg	12.500 kg
Arm crowd force	9.300 kg	8.500 kg	7.900 kg
Arm crowd force at PowerMax	9.700 kg	8.800 kg	8.100 kg



Working Range



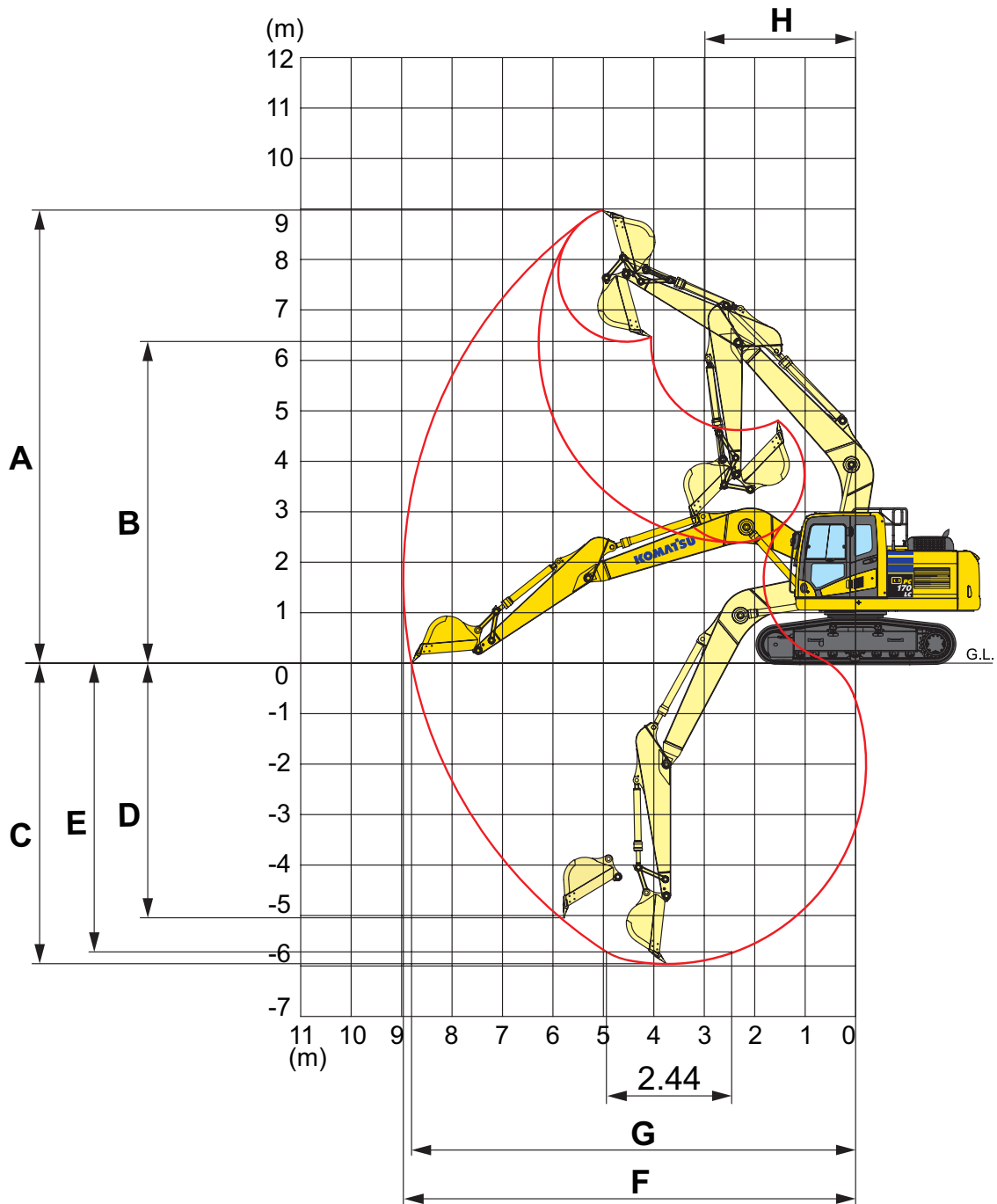







MONO BOOM



ARM LENGTH	2,25 m	2,6 m	2,9 m
A Max. digging height	8.910 mm	8.980 mm	9.130 mm
B Max. dumping height	6.280 mm	6.370 mm	6.525 mm
C Max. digging depth	5.610 mm	5.960 mm	6.250 mm
D Max. vertical wall digging depth	4.860 mm	5.040 mm	5.320 mm
E Max. digging depth of cut for 2,44 m level	5.375 mm	5.740 mm	6.050 mm
F Max. digging reach	8.680 mm	8.960 mm	9.235 mm
G Max. digging reach at ground level	8.510 mm	8.800 mm	9.075 mm
H Min. swing radius	3.040 mm	2.990 mm	2.995 mm

Lifting Capacity

MONO BOOM

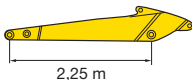
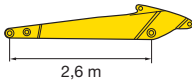
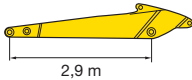
Arm length	A		7,5 m		6,0 m		4,5 m		3,0 m		1,5 m		
	B												
 2,25 m	6,0 m	kg *2.600	*2.600			*3.050	3.050						
	4,5 m	kg *2.550	2.300			*4.450	3.000	*5.000	4.900				
	3,0 m	kg *2.600	2.000	*2.600	1.950	4.700	2.850	*6.400	4.550	*9.900	8.450		
	1,5 m	kg *2.900	1.850	3.150	1.850	4.550	2.700	7.250	4.200				
	0,0 m	kg 3.250	1.900	3.100	1.800	4.400	2.600	7.000	4.000	*6.800	*6.800		
	- 1,5 m	kg 3.600	2.100			4.350	2.550	6.900	3.950	*9.600	7.600	*6.450	*6.450
	- 3,0 m	kg 4.600	2.700			4.400	2.600	6.950	4.000	*10.350	7.750	*9.600	*9.600
- 4,5 m	kg *4.800	4.700							*7.000	*7.000			
 2,6 m	6,0 m	kg *2.150	*2.150			*3.350	3.100						
	4,5 m	kg *2.100	*2.100			*4.200	3.050						
	3,0 m	kg *2.200	1.850	3.250	1.950	4.750	2.900	*6.000	4.600	*8.700	*8.700		
	1,5 m	kg *2.400	1.750	3.150	1.850	4.550	2.750	7.300	4.250	*7.550	*7.550		
	0,0 m	kg *2.850	1.750	3.100	1.800	4.400	2.600	7.000	4.000	*7.350	*5.350		
	- 1,5 m	kg 3.350	1.950			4.350	2.550	6.900	3.900	*9.400	7.500	*4.600	*4.600
	- 3,0 m	kg 4.150	2.450			4.350	2.550	6.950	3.950	*11.050	7.650	*8.800	*8.800
- 4,5 m	kg *5.000	3.900					*5.500	4.100	*8.100	*7.850			
 2,9 m	6,0 m	kg *1.850	*1.850			*3.300	3.100						
	4,5 m	kg *1.800	*1.800	*2.200	2.000	*3.900	3.050						
	3,0 m	kg *1.900	1.700	3.250	1.950	*4.550	2.900	*5.600	4.650	*8.350	*8.350		
	1,5 m	kg *2.050	1.600	3.150	1.850	4.550	2.700	7.150	4.250	*7.700	*7.700		
	0,0 m	kg *2.400	1.650	3.050	1.750	4.350	2.550	7.000	4.000	*6.000	*6.000		
	- 1,5 m	kg *3.000	1.800	3.050	1.750	4.300	2.500	6.800	3.850	*8.950	7.400	*4.400	*4.400
	- 3,0 m	kg 3.750	2.200			4.300	2.500	6.850	3.850	*11.400	7.500	*9.250	*9.250
- 4,5 m	kg *4.900	3.300					*6.050	4.000	*8.850	7.750			

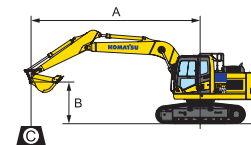

A – Reach from swing center

B – Bucket hook height

C – Lifting capacities, including bucket (495 kg), bucket linkage and bucket cylinder

 – Rating over front











 – Rating over side

 – Rating at maximum reach

With 500 mm shoes

When removing bucket, linkage or cylinder, lifting capacities can be increased by their respective weights

MONO BOOM (WITH ADDITIONAL COUNTERWEIGHT)

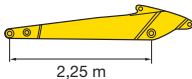
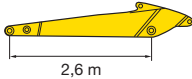
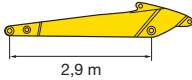
Arm length	A		7,5 m		6,0 m		4,5 m		3,0 m		1,5 m		
	B												
 2,25 m	6,0 m	kg *2.600	*2.600			*3.050	*3.050						
	4,5 m	kg *2.550	2.500			*4.450	3.250	*5.000	*5.000				
	3,0 m	kg *2.600	2.150	*2.600	2.100	*5.000	3.100	*6.400	4.900	*9.900	9.100		
	1,5 m	kg *2.900	2.050	3.400	2.050	4.850	2.950	7.650	4.550				
	0,0 m	kg *3.350	2.100	*3.200	2.000	4.700	2.850	7.450	4.350	*6.800	*6.800		
	- 1,5 m	kg 3.900	2.350			4.650	2.800	7.400	4.300	*9.600	8.200	*6.450	*6.450
	- 3,0 m	kg 4.950	2.950			4.750	2.850	7.300	4.350	*10.350	8.350	*9.600	*9.600
- 4,5 m	kg *4.800	*4.800							*7.000	*7.000			
 2,6 m	6,0 m	kg *2.150	*2.150			*3.350	*3.350						
	4,5 m	kg *2.100	*2.100			*4.200	3.300						
	3,0 m	kg *2.200	2.050	*3.400	2.150	*4.750	3.150	*6.000	4.950	*8.700	*8.700		
	1,5 m	kg *2.400	1.950	3.400	2.050	4.850	2.950	*7.500	4.600	*7.550	*7.550		
	0,0 m	kg *2.850	1.950	3.350	2.000	4.750	2.850	7.500	4.350	*5.350	*5.350		
	- 1,5 m	kg 3.600	2.150			4.650	2.800	7.350	4.250	*9.400	8.150	*4.600	*4.600
	- 3,0 m	kg 4.450	2.700			4.700	2.800	7.400	4.300	*11.050	8.300	*8.800	*8.800
- 4,5 m	kg *5.000	4.250					*5.500	4.450	*8.100	*8.100			
 2,9 m	6,0 m	kg *1.850	*1.850			*3.300	*3.300						
	4,5 m	kg *1.800	*1.800	*2.200	2.200	*3.900	3.300						
	3,0 m	kg *1.900	1.900	3.450	2.100	*4.550	3.150	*5.600	5.000	*8.350	*8.350		
	1,5 m	kg *2.050	1.800	3.400	2.050	4.850	2.950	*7.150	4.600	*7.700	*7.700		
	0,0 m	kg *2.400	1.800	3.300	1.950	4.700	2.800	7.450	4.350	*6.000	*6.000		
	- 1,5 m	kg *3.000	2.000	3.250	1.950	4.600	2.700	7.300	4.200	*8.950	8.000	*4.400	*4.400
	- 3,0 m	kg 4.450	2.400			4.600	2.750	7.300	4.200	*11.400	8.150	*9.250	*9.250
- 4,5 m	kg *4.900	3.600					*6.050	4.350	*8.850	*8.300			

* Load is limited by hydraulic capacity rather than tipping.

Ratings are based on SAE Standard No. J1097.

Rated loads do not exceed 87% of hydraulic lift capacity or 75% of tipping load.

Hydraulic Excavator

PC170LC-10

Standard and Optional Equipment

ENGINE

Komatsu SAA4D107E-2A turbocharged common rail direct injection diesel engine	●
EU Stage IIIB compliant	●
Suction type cooling fan with radiator fly screen	●
Automatic engine warm-up system	●
Engine overheat prevention system	●
Fuel control dial	●
Auto-deceleration function	●
Engine key stop	●
Engine ignition can be password secured on request	●
Alternator 24 V/60 A	●
Starter motor 24 V/4,5 kW	●
Batteries 2 × 12 V/120 Ah	●

HYDRAULIC SYSTEM

Electronic closed-centre load sensing (E-CLSS) hydraulic system (HydrauMind)	●
Pump and engine mutual control (PEMC) system	●
One additional hydraulic circuit	●
6-working mode selection system; power mode, economy mode, breaker mode, attachment power and attachment economy mode, and lifting mode	●
PowerMax function	●
Adjustable PPC wrist control levers for arm, boom, bucket and swing, with sliding proportional control for attachments and 3 auxiliary buttons	●
Prepared for hydraulic quick-coupler	●
Additional hydraulic functions	○

UNDERCARRIAGE

Track roller guards	●
Track frame under-guards	●
LC undercarriage	●
500, 600, 700, 800 mm triple grouser shoes	○

CABIN

Reinforced safety SpaceCab™; highly pressurised and tightly sealed hyper viscous mounted cab with tinted safety glass windows, large roof window with sun shade, pull-up type front window with locking device, removable lower window, front window wiper with intermittent feature, cigarette lighter, ashtray, luggage shelf, floor mat	●
Heated, high back air suspension seat with lumbar support, console mounted height adjustable arm rests, and retractable seat belt	●
Automatic climate control system	●
12/24 Volt power supplies	●
Beverage holder and magazine rack	●
Hot and cool box	●
Radio	●
Auxiliary input (MP3 jack)	●
Lower wiper	○
Rain visor (not with OPG)	○
Sun roller blind	○

SERVICE AND MAINTENANCE

Automatic fuel line de-aeration	●
Double element type air cleaner with dust indicator and auto dust evacuator	●
KOMTRAX™ – Komatsu wireless monitoring system	●
Multi-function video compatible colour monitor with Equipment Management and Monitoring System (EMMS) and efficiency guidance	●
Toolkit	●
Komatsu CARE	●
Service points	○

WORK EQUIPMENT

Mono boom	○
2,25 m; 2,6 m; 2,9 m arms	○

SAFETY EQUIPMENT

Rear view camera system	●
Electric horn	●
Overload warning device	●
Audible travel alarm	●
Boom safety valves	●
Large handrails, rear-view mirrors	●
Battery main switch	●
ROPS compliant to ISO 12117-2:2008	●
Emergency engine stop switch	●
Arm safety valve	●
OPG Level II front guard (FOPS), hinged type	○
OPG Level II top guard (FOPS)	○

DRIVES AND BRAKES

Hydrostatic, 2-speed travel system with automatic shift and planetary gear type final drives, and hydraulic lock service brakes	●
PPC control levers and pedals for steering and travel	●

LIGHTING SYSTEM

Working lights: 2 revolving frame, 1 boom	●
Additional working lights: 4 cab roof (front), 1 cab roof (rear), 1 boom, 1 counterweight (rear), beacon	○

OTHER EQUIPMENT

Standard counterweight	●
Remote greasing for swing circle and pins	●
Electric refuelling pump with automatic shut-off function	●
Biodegradable oil for hydraulic system	○
Additional counterweight 3.500 kg	○

Further equipment on request

- standard equipment
- optional equipment

Your Komatsu partner:

KOMATSU

Komatsu Europe International NV
 Mechelsesteenweg 586
 B-1800 VILVOORDE (BELGIUM)
 Tel. +32-2-255 24 11
 Fax +32-2-252 19 81
www.komatsu.eu

UENSS16904 2/2017

Materials and specifications are subject to change without notice.
KOMATSU is a trademark of Komatsu Ltd. Japan.